



***LifeSize® Room™ Installation Guide***

---

## November 2009

### Copyright Notice

©2005 - 2009 LifeSize Communications Inc, and its licensors. All rights reserved.

LifeSize Communications has made every effort to ensure that the information contained in this document is accurate and reliable, but assumes no responsibility for errors or omissions. Information in this document is subject to change without notice. Companies, names, and data used in examples herein are fictitious unless noted. This document contains copyrighted and proprietary information, which is protected by United States copyright laws and international treaty provisions. No part of the document may be reproduced or transmitted, in any form or by any means, electronic or mechanical, for any purpose, without the express written permission from LifeSize Communications.

### Trademark Acknowledgments

LifeSize® is the trademark of LifeSize Communications Inc. All other trademarks are the property of their respective owners.

### Patent Notice

For patents covering LifeSize® products, refer to <http://www.lifesize.com/support/legal>.

### Contacting Customer Support

If you have questions, concerns, or need assistance, contact your LifeSize Partner.

### Providing Customer Feedback

LifeSize Communications welcomes your comments regarding our products and services. If you have feedback about this or any LifeSize product, please send it to [feedback@lifesize.com](mailto:feedback@lifesize.com). Contact information for LifeSize Communications is as follows:

<i>Method</i>	<i>Address</i>
Internet	<a href="http://www.lifesize.com">http://www.lifesize.com</a>
E-mail	<a href="mailto:support@lifesize.com">support@lifesize.com</a>
Phone	(877) LIFESIZE or (877) 543-3749 (512) 347-9300
Fax	(512) 347-9301

---

## Preparing for Installation

As you prepare to install a LifeSize video communications system, consider the physical conditions of the room, compatibility with displays and your network configuration and settings. LifeSize recommends you collect your network settings and system identification information before you begin installation. Refer to “Initial Configuration” on page 5, which explains what information you need to collect and provides space to record it.

### Room Configuration

The size, shape, layout and occupancy of the room dictate where you place your video conferencing components. For example, in a multi-user conference room, place a LifeSize MicPod or LifeSize Phone at the center of the participants as their detection patterns are omnidirectional.

---

**Warning:** Avoid routing cables from the codec across foot-traffic areas as tripping on the cables can cause both personal injury and permanent damage to the connectors in the cables and codec. If cables must cross foot-traffic areas, use some form of cable management system or strategy to avoid the possibility of tripping.

---

The lighting in your environment affects image quality. The optimal lighting for LifeSize systems is 300 to 500 LUX. If light levels are too low, consider adding artificial lighting. Indirect light from shaded sources or reflected light from pale walls often produces excellent results. Avoid the following:

- direct sunlight on the subject matter, the background, or the camera lens
- direct illumination of the subject matter and camera lens
- colored lighting
- harsh side lighting or strong light from above

Consult your administrator or LifeSize Partner for specific lighting requirements for your environment.

---

## Supported Display Types and Resolutions

LifeSize video communications systems connect to most 720p HD displays, including:

- Plasma, LCD, and LED flat panel displays
- Large screen rear projection TV displays (720p displays)
- Front projection displays
- Rear projector A/V room configurations

Supported display resolutions include the following:

- 720p component video output
- VGA 1280 x 720 output
- VGA 1280 x 768 output

If you connect your LifeSize system to an unsupported display, the user interface may not appear correctly or you may see distorted images. Some unsupported displays may initially appear to work. However, you may experience significant quality and performance issues and the system may not operate properly. To achieve optimal resolution, use the HD-15 to Component RCA cables included with your system.

**Note:** LifeSize recommends using a dual display configuration for presentations in LifeSize Room.

## Placement Behind a Firewall

LifeSize recommends that you place your system behind a firewall and block, at minimum, the following ports:

- 22 (SSH)
- 23 (Telnet)
- 80 (HTTP)
- 443 (HTTPS)

If you require these ports to remain open, ensure that you change the default administrator and command line interface passwords to be very secure. For information about changing the default administrator password, refer to the *LifeSize Video Communications Systems Administrator Guide*.

For information about changing the command line interface password, refer to the *LifeSize Automation Command Line Interface* document available on the Support page of [www.lifesize.com](http://www.lifesize.com).

---

You can also disable SSH and web access on the system by configuring preferences in the user interface. By default, Telnet access is disabled. For more information, refer to the *LifeSize Video Communications Systems Administrator Guide*.

## Network Bandwidth

Poor audio and video quality may result from insufficient bandwidth on your network. LifeSize recommends that your network be capable of at least 1 Mb/s (incoming and outgoing) for a high definition video call. During video calls with lower bandwidths, LifeSize systems automatically select the best resolution that can be achieved with the available bandwidth.

## Domain Name Service Server

If you intend to use domain addresses for placing calls you must have a Domain Name Service (DNS) server configured or use a Dynamic Host Configuration Protocol (DHCP) server that automatically sets a DNS server.

## Initial Configuration

During the installation process, your LifeSize system prompts you to configure it for the first time. LifeSize recommends that you gather all the necessary information prior to installation. The following sections provide guidelines for collecting and a means of recording this data. You may need to consult your network administrator for network settings and system identification information.

**Note:** The initial configuration screens also appear when you perform a system reset. For more information, refer to “Restoring Default Settings” in the *LifeSize Video Communications Systems Administrator Guide*.

## Language

Select the language to display in the user interface. The default is English.

---

## Administrator and User Passwords

Some functions and preferences available from the user interface are accessible only to administrative users with a password. For security reasons, LifeSize recommends that you change the default administrator password (1 2 3 4) during the initial configuration.

Optionally, you can set a user password to control access to user preferences that enable the user to do the following:

- Change the appearance of the user interface.
- Specify how calls are answered.
- Configure audio settings.
- Change cameras and VGA input settings.
- Reboot the system.

The administrator and user passwords can contain any combination of the numbers 0-9 and the symbols \* (star) and # (pound) up to 16 characters in length.

**Note:** If you set a user password, you can also use the administrator password to access user preferences.

Administrator Password: \_\_\_\_\_

User Password: \_\_\_\_\_

## System Identification

Information that identifies the system to users appears throughout the user interface.

Set the **Location** preference to your location. The default is the United States. The **Time Zone** preference sets the system time that appears in the status bar on the main page of the user interface. It defaults to Greenwich Mean Time. You must set this preference even if you specify an NTP server during the initial configuration (refer to “Network Settings” on page 7).

The **System Name**, **Video Number**, and **Voice Number** appear in the user interface on the main screen. The system name may also appear in the local and corporate directories. LifeSize recommends that you change the default system name to one that meaningfully identifies the system to your users.

System Name: (to identify this installation in the network): \_\_\_\_\_

Video Number: \_\_\_\_\_

Phone Number: \_\_\_\_\_

---

## Video and Voice Dialing Preferences

LifeSize systems support either the IP or ISDN protocol for video dialing. The default setting for the **Video Dialing** preference is *Auto* which enables the system to determine the best method to use to place calls.

You can select either *VoIP*, *ISDN*, *Touch Tone* or *Pulse* for the **Voice Dialing** preference. For voice calls, *VoIP* uses H.323 or SIP, *Touch Tone* and *Pulse* use PSTN. The default is VoIP.

When placing a call using the **Voice** button on a LifeSize Phone connected to the system and voice dialing is set to touch tone or pulse, you can only dial phone numbers using PSTN connectivity. When voice dialing is set to VoIP, you can dial IP addresses as well as phone numbers.

When placing a call using the remote control or using the **Video** button on the phone you can dial either phone numbers or IP addresses. This enables systems inside a corporate network without access to a gateway to call other LifeSize systems in the network using system IP addresses.

## Network Settings

By default, DHCP is enabled on LifeSize systems. If you choose *Disabled* for the **DHCP** preference, you must enter an **IP address** (the locally configured IP address if not assigned by a DHCP server), **Subnet Mask** (used to partition the IP address into a network and host identifier), and **Default Gateway** (the IP address of the default gateway the system uses).

IP Address: \_\_\_\_\_

Subnet Mask: \_\_\_\_\_

Default Gateway: \_\_\_\_\_

You can enter the **Hostname** of the system. If you do not have a DHCP server that automatically sets a DNS server, you can enter the IP addresses to configure **DNS Servers**. You can also define the domain names to search when resolving hostnames. DNS translates names of network nodes into addresses; specify this preference to use DNS to resolve the hostnames of devices to IP addresses.

Hostname: \_\_\_\_\_

DNS Servers: \_\_\_\_\_

Name Search Domains: \_\_\_\_\_

If you choose an option other than *Auto* (the default) for the **Network Speed** preference, ensure that the option matches the speed and duplex configured on your network switch.

Network Speed: \_\_\_\_\_ Network Duplex: \_\_\_\_\_

---

You can enter the hostname or IP address of a Network Time Protocol (NTP) server to set the system date and time automatically. The LifeSize system ignores the value you specify for the NTP Server Hostname if the **DHCP** preference is set to *Enabled* and the DHCP server can pass an NTP server address to the LifeSize system.



Network Time Protocol (NTP): \_\_\_\_\_

### Audio Preferences: Active Microphone

The default for **Active Microphone** is *Auto*. The system detects attached audio devices and makes one of them the active microphone in this order:

- phone
- microphone in
- active camera
- inactive camera

If you wish to use a device connected to line in on the codec as the active microphone, you must choose the corresponding line in option manually for **Active Microphone**.

The **Active Microphone** field in the **System Information** page shows which device is functioning as the active microphone. When the value is **None**, the No Active Microphone indicator  appears in the status bar on the main screen of the user interface indicating that no active microphone is available. You can view the **System Information** page after you install the system and complete the initial configuration. From the main screen, press the  button on the LifeSize remote control.

**Note:** If you choose *Line In* or *Line In (No AEC)* as the active microphone, and a device is not connected to line in on the codec, the No Active Microphone indicator does not appear in the user interface and the **System Information** page shows *Line In* as the status for **Active Microphone**.

The *Microphone In (No AEC)* and *Line In (No AEC)* options for the **Active Microphone** preference are for use with a microphone that has its own acoustic echo canceller (AEC).

### Audio Preferences: Active Microphone Volume

You can adjust the audio level for the active microphone by selecting **Active Microphone Volume** and pressing **OK** on the LifeSize remote control.

**Note:** A built-in acoustic echo canceller and noise reducer are active when *Microphone In*, *Camera 1*, or *Line In* is the active microphone. The built-in acoustic echo canceller automatically attempts to adjust audio volume for optimum levels.

An audio meter appears below **Active Microphone Volume** when you access the preference. The audio meter follows the digital signal processing, Automatic Gain Control (AGC), and volume and tone controls on the transmitted voice path as depicted in the following illustration.

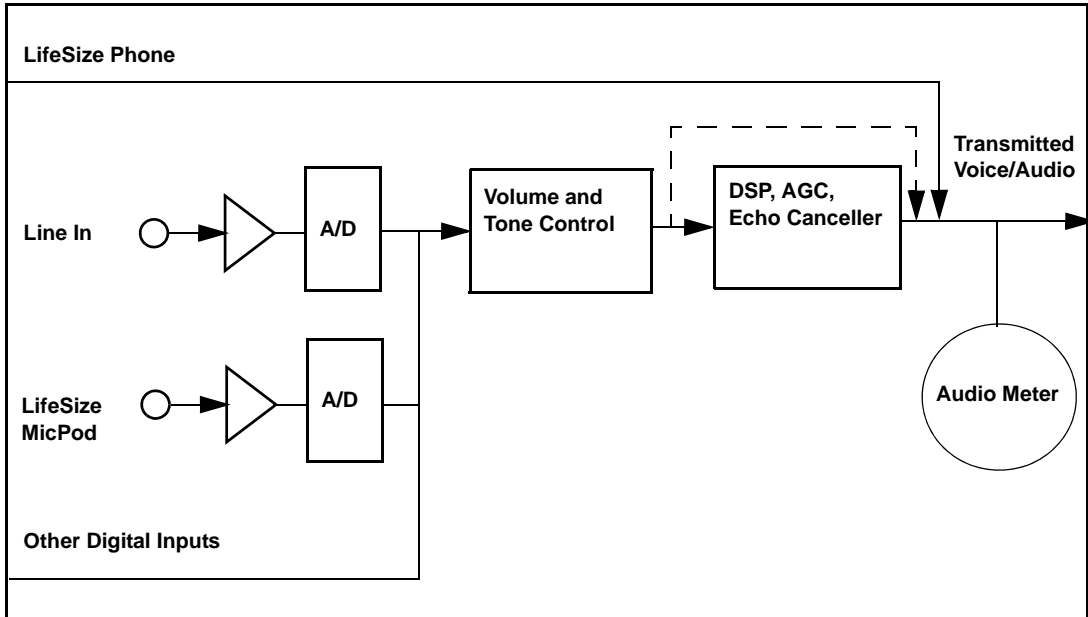

The dotted line illustrates the audio path when *Microphone In (No AEC)*, *Line In 1 (No AEC)*, or *Line In 2 (No AEC)* is selected as the active microphone. This mode is useful for setting up system gains but should never be used during calls unless the installation includes audio inputs with external AEC. Echo may occur if no AEC is employed.

If you choose LifeSize Phone as the active microphone, the **Active Microphone Volume** preference is not available. The LifeSize Phone microphones adjust volume automatically. The voice stream bypasses all processing in the LifeSize system, including the volume and tone controls, and is fed directly into the transmitted voice path.

The audio meter displays the level of the transmitted voice in decibels (dB) root mean square (RMS) below digital full scale (DFS). The meter is accurate to  $\pm 1$  dB. The maximum level is 0 dB. Levels below  $-50$  dB are not displayed, and indicate a very quiet or inactive input. Typical levels during a call peak around  $-28$  to  $-22$  dB DFS. The AEC and AGC attempt to keep the RMS transmit level below  $-20$  dB DFS. The following images show what appears in an audio meter at various levels.



Very Quiet or Inactive Input below -50 dB (no bars)



-20 db DFS Level (Last Green Bar)



-10 db DFS Level (Last Yellow Bar)



0 db DFS Level (Maximum Possible Level; First Red Bar is -9 dB)



### Typical Transmit Voice Level in a Call

When setting **Active Microphone Volume** for LifeSize MicPod or LifeSize Focus, place someone where a participant in a call would normally sit in the conference room and ask the person to speak at a normal volume facing the active microphone.

Use the audio meter to visually verify that the transmit level peaks in the desired -28 to -22 dB range.

LifeSize recommends a volume setting of 5 to 8 for **Active Microphone Volume** for most LifeSize MicPod applications.

---

LifeSize recommends a volume setting of 5 to 10 for Active Microphone Volume for most LifeSize Focus applications.

If you set **Active Microphone Volume** to a line in option when using an external mixer or amplified microphone, follow these steps:

1. Select *Line in (no AEC)* for **Active Microphone**.
2. Position someone approximately one meter from the microphone, facing it, speaking at a normal volume.
3. Adjust the **Active Microphone Volume** and the external mixer output level until the meter peaks in the -28 to -22 dB range. LifeSize recommends you adjust the external mixer volume so that you achieve peak levels in the -28 to -22 dB range of the audio meter with the **Active Microphone Volume** control no less than 5 or greater than 15.
4. If the microphone or mixer you use employs an echo canceller, no further adjustments are necessary. Otherwise, select *Line In* for **Active Microphone**. This turns on the LifeSize system's echo canceller, noise reduction, and automatic gain control functions. If you do not use an echo canceller, you may experience severe echo effects.
5. After the adjustment, check that the peak levels when speaking normally one meter from the microphone are in the -28 to -22 dB range. The AGC attempts to keep the transmit level below -20 dB, which is the green range of the bar graph.

An audio meter is also available for the **Line In Volume** preferences for setting an audio level for a device connected to line in on the codec when the line in is not selected as the active microphone.

### **Audio Preferences: Video and Voice Call Output**

If you plan to use external speakers other than LifeSize Phone for audio in both video and voice calls, ensure that the **Video Call Audio Output** and **Voice Call Audio Output** preferences are set to *Line Out*. If you are using LifeSize Phone for audio, set these preferences to *Phone*. By default, **Video Call Audio Output** is set to *Line Out*, **Voice Call Audio Output** is set to *Phone*.

---

## Audio Preferences: Testing Speakers

You can also test the primary output speakers for the appropriate audio level or to ensure they are working properly. Select *Auto* for **Primary Audio Output Test** to cycle through a test on your available speakers. The test continues until you select *Off*. You can also send the tone to either the left, center, or right channel by choosing *Test Left*, *Test Center*, or *Test Right*. The tone is sent to line out.

You can send audio test tones to speakers that are connected to the auxiliary audio outputs on the LifeSize Room codec. Select *Auto* for **Auxiliary Audio Output Test** to cycle through all available channels. The test tone plays for 5 seconds before moving to the next available channel. The test continues until you select *Off*. You can also send the tone to either the left or right auxiliary channel by choosing *Test Left* or *Test Right*.

## LifeSize Room Components

Your LifeSize Room package contains the following components:

- One or more audio component(s) (only one can be the active microphone at a time):
  - LifeSize Phone
  - LifeSize MicPod—see “Configuring Dual LifeSize MicPods” on page 18 for the dual LifeSize MicPod option
- One or more of the following cameras and cables:
  - LifeSize Camera with standard 7.5 meter (24.6 foot) cable, optional 15 meter (49.2 foot) cable
- LifeSize Room Codec
- LifeSize Remote Control (including three AAA batteries)
- Quick reference card
- Documentation CD

---

## Installing a LifeSize Room System

Before you install a LifeSize video communications system, read the document *LifeSize Safety and Regulatory Notices* for important safety information. The document is available on the documentation CD-ROM and from the Support page of [www.lifesize.com](http://www.lifesize.com).

---

**Warning:** Exercise care when connecting cables to the codec to avoid damaging cables or the connectors on the codec. Face the back of the codec or ensure that all connectors are visible when connecting a cable to the codec.

---

To install the components of your LifeSize system, remove all components from the product packaging, including cables, and place them in the desired positions in your conference room.

---

**Warning:** Do not place anything on top of or adjacent to the codec that can obstruct air flow around the unit or generate heat. Doing so can cause the system to overheat and reboot. Prolonged overheating can result in damage to the codec. Ensure the room that houses the codec is properly ventilated and temperature controlled.

---

Refer to the LifeSize quick reference card included with your system for a visual depiction of the proper setup. The numbers that appear on the quick reference card correspond to the following steps:

1. Open the battery compartment on the back side of the remote control.
  - a. Before inserting the batteries, stretch each of the two straps across the outer battery slot closest to it.
  - b. Insert the two outer batteries, negative end (-) first against the spring, then press the positive (+) end into place, trapping the cloth straps beneath the batteries.
  - c. Lay the longer cloth strap over both batteries and insert the center battery's negative end against the spring first to trap the longer cloth strap beneath it. Then press the positive end of the battery into place.
  - d. Lay the ends of the cloth straps over the center battery and install the cover.
2. Insert the codec into its stand by aligning the pin holes at the base. Secure the codec in the stand by tightening the bolt on the bottom of the codec stand. *Optional:* Insert the rubber feet on the bottom of the codec stand.

**Note:** When inserting the necessary cables into the back of the codec, LifeSize recommends you route them through the plastic strain relief guide at the bottom of the unit to keep all cables secure.



- 
3. To connect a LifeSize Camera to the codec, insert the camera cable into the port on the rear side of the camera and plug the opposite end into the port marked with the camera 1 symbol  on the back of the codec.

If you purchased a second LifeSize Camera for use with LifeSize Room, insert the camera cable for the second camera into the port on the rear side of the camera and plug the opposite end into the port marked with the camera 2 symbol  on the back of the codec. For more information about using two cameras with your LifeSize Room system, refer to your *LifeSize Video Communications Systems User Guide*.

To connect a supported third-party camera using a LifeSize SDI Adapter, refer to the *LifeSize SDI Adapter Installation Guide*.

4. Insert the video display cable into the port on the rear of your display and the opposite end into the port marked with the display 1 symbol  on the back of the codec. Insert the display power cord into a power outlet on the wall.

To connect a second display to LifeSize Room, insert the video display cable into the port on the rear of your display and the opposite end into the port marked with the display 2 symbol  on the back of the codec. Attach the display power cord to a power outlet. By default, the second display is blank and displays a message directing you to configure preferences for the display. After you complete the initial configuration, refer to “Configuring a Second Display” on page 16 to complete this process.

5. Insert the audio cable into the port on your display and the opposite end into the line out port marked with the  symbol on the back of the codec.
6. Insert the network cable into the network port marked with the LAN symbol  on the back of the codec. Insert the opposite end of the network cable into a network port on the wall.
7. Do one of the following:

- a. If you are using the LifeSize Phone for audio, insert the phone cable into the port marked with the LAN symbol  on the underside of the phone.

**Note:** The exterior port marked with the  symbol on the LifeSize Phone is reserved for future use.

Insert the opposite end of the phone cable into the port marked with the LifeSize Phone symbol  on the back of the codec. Ensure the cables are secured into the guides to avoid damage to them.

**Note:** When the LifeSize Phone is connected to a LifeSize video communications system, you are unable to configure it as a standalone speakerphone. Configure your system using the LifeSize video communications system interface.

- 
- b. If you are using the LifeSize MicPod for audio, insert the end of the cable from the LifeSize MicPod into the microphone port marked with the microphone symbol  on the back of the codec. LifeSize recommends you route this cable through the strain relief guide on the stand. If the LifeSize MicPod is installed in an area where the cord could be pulled or tripped upon, refer to “Attaching the LifeSize MicPod Strain Relief Clip” on page 19.

---

**Warning:** Tripping on the LifeSize MicPod cord can cause personal injury as well as permanent damage to the LifeSize MicPod cord connector and the connector in the codec. LifeSize recommends that you use the cable strain relief clip included in the LifeSize MicPod product box as described in “Attaching the LifeSize MicPod Strain Relief Clip” on page 19.

---

If you are using dual LifeSize MicPods for audio, refer to “Configuring Dual LifeSize MicPods” on page 18 for a description of supported configuration options.

8. Insert the cord from the power adapter into the power outlet marked **DC 19V**  on the back of the codec (near the base). Insert one end of the power cord into the power adapter and the opposite end into a power outlet on the wall.

The LifeSize system starts and illuminates a blue LED on the front of the codec. See “Status Icons” on page 25 for more information about the state of the system as it boots or as conditions change.

The camera initializes the first time it is connected to a codec; this process takes approximately 90 seconds.

---

**Warning:** Do not disturb or disconnect the devices during this time as you may damage the system.

---

9. An **Initial Configuration** screen appears and prompts you to configure the system. Refer to “Initial Configuration” on page 5 and the information you collected there previously to guide you through your configuration choices. Use the arrow keys on the remote control to navigate the preferences that appear in the initial configuration screens. Icons that appear at the bottom of each screen correspond to keys on the remote control and indicate what operations are available for the screen or a selected object.

**Note:** If the initial configuration screen does not appear and the display is blank, refer to “Troubleshooting Installation Issues” on page 20.

---

The bottom of the screen contains the system status bar and the navigation bar. The system status bar indicates system and network status. When the system is booting, status also appears at the top of the **REDIAL** list to indicate the current state of the system. See “Status Icons” on page 25 for an explanation of status icons you may encounter.

## Connecting a PSTN Phone Line

If you chose either the *Touch Tone* or *Pulse* options for the **Voice Dialing** preference during the initial configuration, ensure that you connect an RJ-11 PSTN phone cord to the PSTN phone port labeled  on the LifeSize codec and the other end to a phone jack on the wall.

## Locking the LifeSize Codec

You can lock the LifeSize codec with a secure loop to prevent physical removal of the device. For assistance, contact your LifeSize Partner or LifeSize Customer Support.

## Configuring a Second Display

If you installed a second display, you must configure it. Navigate to **Administrator Preferences : Appearance : Layout** and choose **Display 2 Layout**, which, by default is set to *None*.

- Choose *Presentations + VGA Input* to display presentations (local and remote) during a call that is sending or receiving a presentation. When not in a call, VGA input appears in the display.
- Choose *Calls + Presentations + VGA Input* to display:
  - video images from video calls
  - presentations (local and remote) in a call that is sending or receiving a presentation
  - VGA input when not in a call
- Choose *Simulcast Calls + VGA Input* to show the same output on Display 2 as shown on Display 1 during calls.

---

## Optional Peripherals

You can connect the following optional peripherals to enhance your LifeSize system:

Peripheral	Usage
Serial RS-232	For use with a LifeSize SDI Adapter, supported third-party cameras, and for automation control with Crestron and AMX controllers.
Composite and SD Interfaces	Standard video for use with a third party camera or DVD player.
HD Camera 2	For use with a second LifeSize Camera.
Microphone in	For use with a single or dual LifeSize MicPod configuration In a single LifeSize MicPod configuration, you can add a LifeSize MicPod extension cable (15 meters, 49.2 feet) to the LifeSize MicPod. In a dual LifeSize MicPod configuration, you use a combination of two LifeSize MicPods, one splitter cable, and extension cables in large rooms to create wider coverage of audio input. Refer to "Configuring Dual LifeSize MicPods" on page 18 for supported configurations.
Document Camera In	Standard video for use with a third party camera.
VGA In	VGA port for connecting laptops for presentations or to share PC data. For information about supported VGA input resolutions, refer to the <i>LifeSize Video Communications Systems Administrator Guide</i> .
Audio In (Line In)	For use with an external line level audio input, in addition to the LifeSize Phone or LifeSize MicPod.
Networker	For use with LifeSize Networker.
Analog phone line in	For PSTN connectivity.
Auxiliary Audio In	Stereo line input for connecting an audio device with line level output. <sup>a</sup>
Auxiliary Video In	Standard composite or s-video input for connecting a device that outputs composite or s-video.
Auxiliary Audio Out	Stereo line level output for connecting a device that has a line level input. <sup>b</sup>
Auxiliary Video Out	Standard composite or s-video output for connecting a device that has composite or s-video inputs.

a. Auxiliary Audio In and Auxiliary Video In are typically used to connect a DVD or VCR to share standard video and audio content with the far end during a presentation or to view the content locally.

b. Auxiliary Audio Out and Auxiliary Video Out are typically used to connect a DVR or VCR to record the video and audio from a call in Standard Video format.

---

## Configuring Dual LifeSize MicPods

If you are using dual LifeSize MicPods, you can use the splitter cable to connect a combination of extension cables and two LifeSize MicPods to the single LifeSize MicPod port on your LifeSize codec for maximum omnidirectional audio coverage in large conference rooms.

Dual LifeSize MicPod configurations are limited to two LifeSize MicPods and one splitter cable. (You cannot use multiple splitters to connect to more than two LifeSize MicPods.) However, you can use variations on three configurations of extension cables:

- If you connect the male end of the splitter directly to the codec, you can use none, or one extension cable to connect a LifeSize MicPod to each of the female ends of the splitter.
- If you use one extension cable to connect the codec to the splitter, you can use none, or one extension cable to connect a LifeSize MicPod to each of the female ends of the splitter.
- If you use two extension cables to connect the codec to the splitter, you must connect both LifeSize MicPods directly to the female ends of the splitter.

If the LifeSize MicPods are installed in an area where the cord could be pulled or tripped upon, refer to “Attaching the LifeSize MicPod Strain Relief Clip” on page 19.

---

**Warning:** Tripping on the cord can cause personal injury as well as permanent damage to the LifeSize MicPod cord connector and the connector in the codec. LifeSize recommends that you use the cable strain relief clip included in the LifeSize MicPod product box as described in “Attaching the LifeSize MicPod Strain Relief Clip” on page 19.

---

A LifeSize codec detects any splitter or cable attached to the microphone input of the codec as a LifeSize MicPod. If a LifeSize MicPod is not attached to the extension or splitter cable and the microphone input is selected as the active microphone, no audio is available. The No Active Microphone indicator does not appear in the status bar and the **Active Microphone** field in the **System Information** page reports *Microphone In* as the active microphone.

---

## Attaching the LifeSize MicPod Strain Relief Clip

If the LifeSize MicPod is installed in an area where the cord could be pulled or tripped upon, LifeSize recommends using the strain relief clip included with your LifeSize MicPod to reduce the chance of disconnecting or damaging the plug or the LifeSize video communications system codec.

Before attaching the strain relief clip to the codec, ensure that the codec surface is clean (free of dirt, dust, oil, and other residues) and dry. The adhesive tape on the strain relief clip is intended for a single use. Attach the strain relief clip to the codec and route the LifeSize MicPod cable through the strain relief clip as shown in the following diagram.

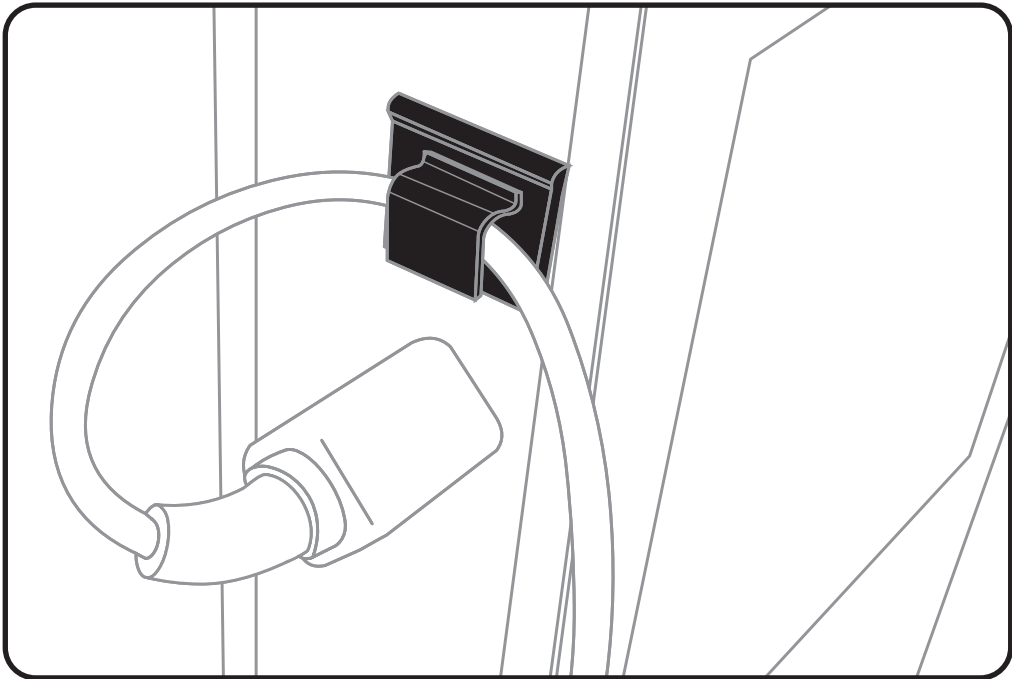

To obtain a replacement strain relief clip, contact your LifeSize Partner.

---

## Verifying Your Installation

The *LifeSize Video Systems Administrator Guide* explains how to place a test call to verify your installation. It also explains additional adjustments you may need to make to your LifeSize configuration and your network if you use:

- Network Address Translation (NAT)
- a firewall
- H.323 gatekeepers
- Session Initiation Protocol (SIP)
- other network security systems

## Troubleshooting Installation Issues

Installation issues that you may encounter with your LifeSize system typically involve issues with VGA output, improperly connected cables, or network bandwidth or connectivity. For information about troubleshooting other issues that users may encounter with LifeSize systems refer to the *LifeSize Video Communications Systems User Guide*.

Improperly connected or loose cables are common causes of problems with hardware units. When investigating a system problem, first inspect all the external controls and cable connections. Ensure that connections are correct and secure, and that nothing is obstructing the cables.

### Display Issues with VGA Output

Some displays do not support automatic detection of their VGA display capabilities and LifeSize systems are unable to detect the monitor. The following conditions may occur with some VGA monitors:

- Failure to read the Extended Display Identification Data (EDID) of the display.  
The system detects the display as VGA, but cannot determine its supported resolutions. The system configures the display output to VGA at 1280x768. EDID is a VESA standard data format that contains general information about a display and its capabilities, including vendor information, maximum image size, color characteristics, factory pre-set timings, frequency range limits, and character strings for the display name and serial number.
- Failure to detect the display as a VGA device.  
The system configures the output to 720p. Most VGA monitors display this signal; however, the data is not centered and may be tinted green. You must manually configure the appropriate display as VGA to resolve this issue.

- 
- The resolution of the display is unsupported.

The system requires displays that support 1280x720 or 1280x768 resolutions. If a VGA display EDID does not contain one of these resolutions, The system automatically configures it for 1280x768. Most multi-sync VGA displays can adjust to this resolution and scale the data to fit the screen, which is typically 4x3. If scaling occurs, the resulting image may be slightly distorted. For example, a display that only supports 1024x768 will scale the 1280x768 image causing it to appear narrow. If a display cannot adjust to the 1280x768 resolution, its screen remains blank. The system does not support displays that do not support 1280x768.

When the system does not automatically address one of these conditions, you must manually configure the display output. You can configure the display output from the LifeSize user interface or from the LCD interface on the LifeSize Phone connected to your LifeSize system as described in the following sections.

## Configuring Display Output from the LifeSize Interface

If your display shows the initial configuration screen but the image is distorted and unusable or the display is blank, you must configure the display from the LifeSize Phone. Refer to “Configuring Display Output from LifeSize Phone” on page 22.

To resolve problems with monitors from the LifeSize interface, follow these steps:





1. Ensure that no calls are in progress.
2. From the main screen, press  on the remote control to access the **System Menu**.
3. Select **Administrator Preferences** and press **OK**.
4. Enter the administrator password and press **OK**.
5. Select **Appearance** and press **OK**.
6. Select **Displays** and press **OK**.
7. If you are resolving problems with a VGA monitor, select **VGA** for the **Display Type** preference for the display you wish to manually configure.
8. If your display supports both 1280x720 and 1280x768, you can manually configure the system to use one of these resolutions by setting the **Display Resolution** preference for the display you wish to manually configure.



---

## Configuring Display Output from LifeSize Phone



If the initial configuration screen appears distorted and unusable or the attached display is blank, you must configure your display from the administrator interface on the LifeSize Phone.

To resolve problems with monitors from the LifeSize Phone interface, follow these steps:

1. Ensure that no calls are in progress.
2. Log in to the **Admin Menu** on your LifeSize Phone.
  - a. Press     sequentially when the phone is idle.
  - b. Enter the administrator password (1 2 3 4 by default) and press .
3. Press **1** on the keypad to select **Preferences**.
4. Press **1** on the keypad to select **Display 1**.

5. Press the  key to select **Auto**. (If you are resolving problems with a VGA monitor, select **VGA** for the **Display Type** to manually set the display to VGA. If your display supports both 1280x720 and 1280x768, you can manually configure the system to use one of these resolutions by setting the **Display Resolution** preference.)
6. Press the  key again to accept your change(s).



**Note:** If you remain idle on any preference screen for two minutes, you return to the main screen.

7. When you have finished setting preferences, press the  key to save them.
8. Press  to return to the previous screen.

---

## IP Address Displays Invalid Value





After you complete the initial configuration, if the IP address that appears at the top of the main screen displays an invalid value, one of the following conditions may exist:

Condition	Resolution
<p>The unit is configured to obtain an address using DHCP and no DHCP server is available.</p> <p><b>Note:</b> The DHCP client self-assigns an address in the 169.254 class B network and the red network symbol  appears in the status bar on the main screen.</p>	<p>Verify that the unit is plugged into a network that has a DHCP server present.</p>
<p>Faulty Ethernet cable connection.</p>	<p>Replace the Ethernet cable with a high quality cable.</p>
<p>The unit is configured to use a static IP address, but no IP address has been entered.</p>	<p>Identify and enter the necessary IP information if you disable DHCP.</p>
<p>Network connection is unavailable.</p> <p>A red network symbol  appears in the status bar on the main screen.</p>	<p>Inspect your network connection.</p>

---

## Camera Issues

Video from the camera appears in a small window on the main screen of the user interface above the **Redial** list. If no video from the camera appears, do the following:

- Ensure that the camera is properly connected to the LifeSize codec as described in “Installing a LifeSize Room System” on page 13.
- Verify that the blue LED on the front of the camera is lit and not blinking, indicating that power is active.
- From the main screen of the user interface, press  to access the **System Menu**. Press  to access page 2 of the **System Information** page. Ensure that the status of the camera is **Ready**.
- Ensure that the primary input is set to the high definition camera. Press  on the remote control. If **Primary Input : HD Camera** does not appear at the top of the screen, press  to display the **Primary Input** selection dialog. Use the arrow keys on the remote control to select the appropriate high definition camera and press **OK**.

### Improving a Dim Image









If the image is too dim, you can adjust the **HD Camera Brightness** preference in **User (or Administrator) Preferences : Diagnostics : High Definition Camera**.

### Attached Video Input Device Not Working

When you connect a video input device that has capabilities not supported by a LifeSize system, the status **Out of range** appears on the **System Information** page for that input. The device may be in a mode that the codec does not support. Changing the mode may help. Otherwise, the device is not supported.

## Status Icons

The following table identifies the icons that can appear in the system status bar.

Icon	Condition
	Indicates that the communication subsystem is initializing. If this icon reappears after the system has booted, a problem has occurred. Reboot the system.
	Indicates that the system is initializing. When the system is initializing, functionality on the main screen is disabled and no entries appear in the REDIAL list. This icon also appears when a new device is connected to the system after the system boots and disappears when the device is ready. If the icon persists, a problem has occurred and rebooting the system is necessary.
	Indicates that the system does not have an active microphone. Check the device's connections and then check the option you selected for the <b>Active Microphone</b> preference.
	Indicates that the connected phone has been detected and the phone is initializing. If the icon persists, a problem has occurred and rebooting the system is necessary.
Network Status	Identifies the network status, as follows: connected  (green indicator)  in progress  (yellow indicator)  disconnected  (red indicator)
System Overheating	<p>This yellow indicator warns you when the system temperature is above normal operating temperature. The codec adjusts fan speed automatically to cool itself. </p> <p>This red indicator warns that the system is overheated and approaching the maximum allowed operating temperature and will automatically reboot after reaching it. </p> <hr/> <p>Warning: Temperatures that require the codec to reboot can permanently damage codec components. Ensure the room that houses the codec is properly ventilated and temperature controlled.</p> <hr/>